



MATTIOCCO
elastomeri s.r.l.

Stampaggio articoli tecnici in gomma

Profili in gomma

Progettazione e costruzione Antivibranti

Azienda Certificata ISO 9001

Stabilimento e uffici:

Viale Enrico Ortolani, 109
00125 Roma

Telefono 06 5216630 (4 linee r.a.)

Fax 06 5215254

info@mattiocco-elastomeri.com

www.mattiocco-elastomeri.com

TOLLERANZE DIMENSIONALI DEI TRAFILATI IN GOMMA SECONDO UNI ISO 3302

da mm Classe	0,0 1,5	1,6 2,5	2,6 4,0	4,1 6,3	6,4 10,0	10,1 16,0	16,1 25,0	25,1 40,0	40,1 63,0	63,1 100,0
E1	±0,15	±0,20	±0,25	±0,35	±0,40	±0,50	±0,70	±0,80	±1,00	±1,30
E2	±0,25	±0,35	±0,40	±0,50	±0,70	±0,80	±1,00	±1,30	±1,60	±2,00
E3	±0,40	±0,50	±0,70	±0,80	±1,00	±1,30	±1,60	±2,00	±2,50	±3,20

Se non diversamente indicato tolleranze dimensionali UNI ISO 3302/E2

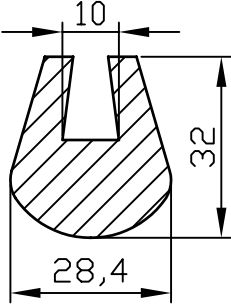
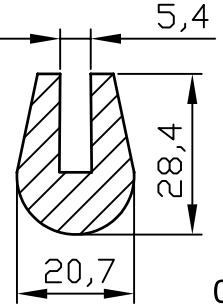
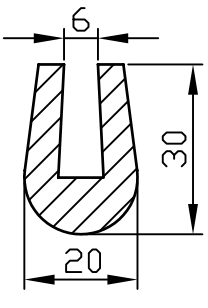
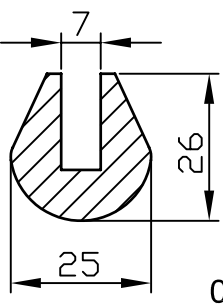
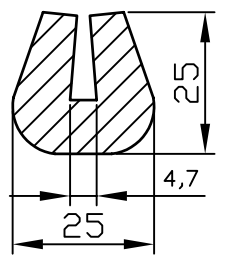
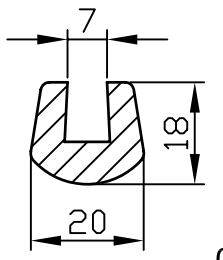
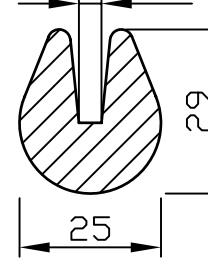
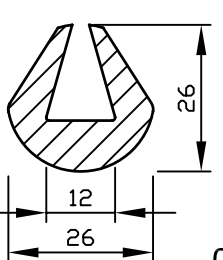
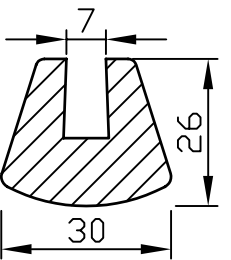
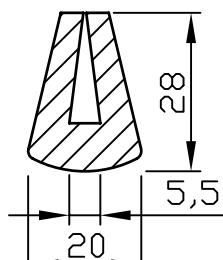
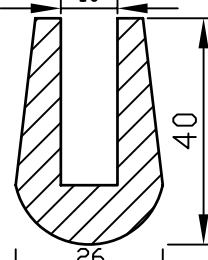
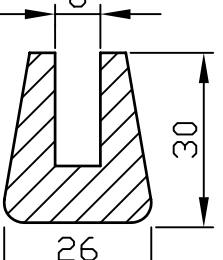
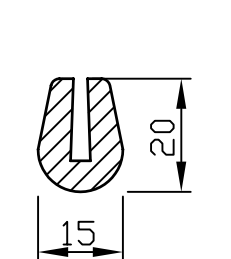
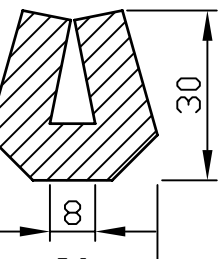
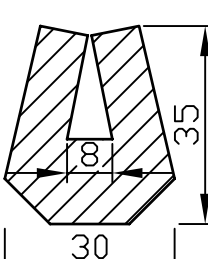
			
			
			
			
17	18	19	20



MATTIOCCO
elastomeri

NOTE

Misure in mm

MATERIALE
EPDM 70±5
Shore A

TITOLO

Profili vagli

Sede e stabilimento di produzione:
Viale Enrico Ortolani, 121 - 00125 Roma
Tel. 065216630 - Fax 065215254
info@mattiocco-elastomeri.com
www.mattiocco-elastomeri.com

FORMA

2A18-XX

DATA ULTIMA REVISIONE | FOGLIO 1 OF 1
18-12-08

TOLLERANZE DIMENSIONALI DEI TRAFILATI IN GOMMA SECONDO UNI ISO 3302

da mm a	0,0 1,5	1,6 2,5	2,6 4,0	4,1 6,3	6,4 10,0	10,1 16,0	16,1 25,0	25,1 40,0	40,1 63,0	63,1 100,0
Classe										
E1	±0,15	±0,20	±0,25	±0,35	±0,40	±0,50	±0,70	±0,80	±1,00	±1,30
E2	±0,25	±0,35	±0,40	±0,50	±0,70	±0,80	±1,00	±1,30	±1,60	±2,00
E3	±0,40	±0,50	±0,70	±0,80	±1,00	±1,30	±1,60	±2,00	±2,50	±3,20

Se non diversamente indicato le tolleranze si intendono secondo UNI ISO 3302/E2

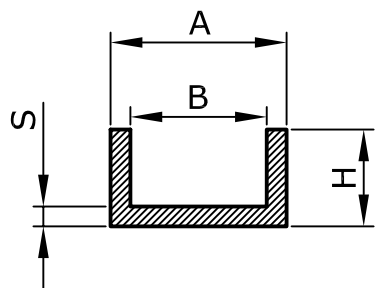

N. MATRICE	A	B	H	S
1551	3	1	5	1
1283	4	2	3,5	0,5
1287	4	2	5,5	0,5
1523	5	3	8	1
805	6	3	16	1,5
1452	7	3	8	2
797	7	3	15	2
625	7	4	14	1,5
1252	7	5	5	1
1104	7	5	8	1
654	7	5	9	1
1202	8	3	8	1,5
1406	8	5	11	1,5
1466	8	6	6	1
1296	8	6	7	1
788	8	6	11	1
1521	8,5	2,5	13,5	3,5
1520	8,5	2,5	23,5	3,5
1151	8,5	5,5	10	1,5
1314	9	3	18	3
815	9,5	2,9	12,7	3,8
1457	10	5	8,5	1,5
T022	10	6	10	2
701	10	6	35	2
1362	10,4	4,3	8	2,8

N. MATRICE	A	B	H	S
1529	11	5	9,5	3
800	11	8	15	1,5
596	12,5	3,5	16	8
1439	13	8	19	2,5
1360	13	12	2	0,5
1390	15	8	12	3
755	18	8	30	5
516	18	15	16	3
1087	19,5	14,5	18,5	2,5
873	20	10	45	5
1162	21	11	10	2
893	21	15	30	7
918	21	17	26	2
656	22	14	22	4
855	23	18	18	1,8
927	23	20	15	1,5
767	30	20	30	10
970	30	22	25	4
1499	32	26	5	2
1424	36	30	33	3
1528	40	20	20	10
652	50	20	45	30
179	80	70	10	5
-	-	-	-	-
-	-	-	-	-
-	-	-	-	-
-	-	-	-	-
-	-	-	-	-
-	-	-	-	-
-	-	-	-	-
-	-	-	-	-
-	-	-	-	-



MATTIOCCO
elastomeri

NOTE
Misure in mm

Sede e stabilimento di produzione:
Viale Enrico Ortolani, 121 - 00125 Roma
Tel. 065216630 - Fax 065215254
info@mattiocco-elastomeri.com
www.mattiocco-elastomeri.com

TITOLO
Profilo a "U" base quadra

FORMA
2A09

DATA ULTIMA REVISIONE
18 / 12 / 08

FUOGGIO 1 OF 1

TOLLERANZE DIMENSIONALI DEI TRAFILATI IN GOMMA SECONDO UNI ISO 3302

da mm a	0,0 1,5	1,6 2,5	2,6 4,0	4,1 6,3	6,4 10,0	10,1 16,0	16,1 25,0	25,1 40,0	40,1 63,0	63,1 100,0
Classe										
E1	±0,15	±0,20	±0,25	±0,35	±0,40	±0,50	±0,70	±0,80	±1,00	±1,30
E2	±0,25	±0,35	±0,40	±0,50	±0,70	±0,80	±1,00	±1,30	±1,60	±2,00
E3	±0,40	±0,50	±0,70	±0,80	±1,00	±1,30	±1,60	±2,00	±2,50	±3,20

Se non diversamente indicato le tolleranze si intendono secondo UNI ISO 3302/E2

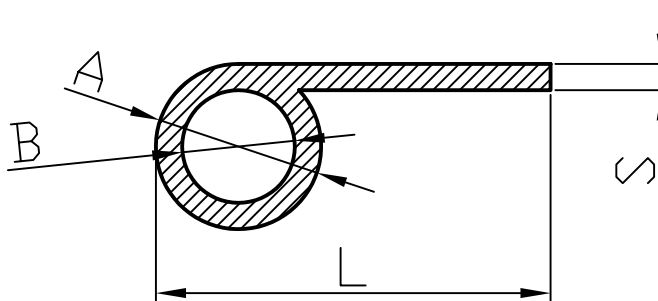

N. MATRICE	A	B	L	S
1267	3	0	14	1
1835	5	2	52,5	1,5
1527	5	3	24	1
1667	6	4	33	1
121	8	5	21	1,5
1526	8	5	32	2
1525	10	7,6	25	1,5
998	10	8	30	2
1771	11	7	31	2
1180	12	8	23	2
1058	12	8	29	2
1120	12	8	34	2
2008	13	9	32	2
669	14	10	35	2

N. MATRICE	A	B	L	S
2001	14	11,5	35	2
1909	15	12	30	1,5
162	21	9	47	7
1820	21,5	8,5	77	11,8
1901	25	20	30	2,5
906	30	6	60	7
1620	40	15	78	15
727	50	40	120	5
841	55	0	112	20
1405	60	30	130	20
-	-	-	-	-
-	-	-	-	-
-	-	-	-	-
-	-	-	-	-



MATTIOCCO
elastomeri

NOTE
Misure in mm

Sede e stabilimento di produzione:
Viale Enrico Ortolani, 121 - 00125 Roma
Tel. 065216630 - Fax 065215254
info@mattiocco-elastomeri.com
www.mattiocco-elastomeri.com

TITOLO

Profilo a "P"

FORMA

2A12

DATA ULTIMA REVISIONE | FOGLIO 1 OF 1
18-12-08

MATTIOCCO elastomeri - Roma

Produzione tubi estrusi

Codice Interno	Diametro		Peso Kg/mt	Matassa mt
	Esterno	Interno		
ME TB-0402-X	4	2	0,012	50
ME TB-0502-X	5	2	0,021	50
ME TB-0503-X	5	3	0,016	50
ME TB-0603-X	6	3	0,028	50
ME TB-0604-X	6	4	0,020	50
ME TB-0703-X	7	3	0,041	50
ME TB-0704-X	7	4	0,034	50
ME TB-0705-X	7	5	0,024	50
ME TB-0802-X	8	2	0,061	50
ME TB-0803-X	8	3	0,056	50
ME TB-0804-X	8	4	0,049	50
ME TB-0805-X	8	5	0,040	50
ME TB-0806-X	8	6	0,029	50
ME TB-0903-X	9	3	0,073	25
ME TB-0904-X	9	4	0,066	25
ME TB-0905-X	9	5	0,057	25
ME TB-0906-X	9	6	0,046	25
ME TB-1005-X	10	5	0,077	25
ME TB-1006-X	10	6	0,065	25
ME TB-1007-X	10	7	0,052	25
ME TB-1008-X	10	8	0,037	25
ME TB-1205-X	12	5	0,121	25
ME TB-1206-X	12	6	0,110	25
ME TB-1207-X	12	7	0,097	25
ME TB-1208-X	12	8	0,082	25
ME TB-1209-X	12	9	0,064	25
ME TB-1210-X	12	10	0,045	25
ME TB-1406-X	14	6	0,163	25
ME TB-1408-X	14	8	0,135	25
ME TB-1410-X	14	10	0,098	25
ME TB-1610-X	16	10	0,159	25
ME TB-1612-X	16	12	0,114	25
ME TB-1710-X	17	10	0,193	25
ME TB-1812-X	18	12	0,184	25
ME TB-1814-X	18	14	0,131	25
ME TB-2012-X	20	12	0,261	25
ME TB-2014-X	20	14	0,208	25
ME TB-2016-X	20	16	0,147	25
ME TB-2218-X	22	18	0,163	25
ME TB-3515-X	35	15	1,020	25

Mescole (X):

1 = EPDM 70

2 = NBR 70

3 = SILICONE 70